



N-Channel and P-Channel Complementary MOSFET

Product Summary

NMOS

V_{DS}	30V
I_D	4A
$R_{DS(ON)}$ (at $V_{GS}=10V$)	35m
$R_{DS(ON)}$ (at $V_{GS}=4.5V$)	55m

PMOS

V_{DS}	-30V
I_D	-3A
$R_{DS(ON)}$ (at $V_{GS}=-10V$)	75m
$R_{DS(ON)}$ (at $V_{GS}=-4.5V$)	110m

General Description

ch Power LV MOSFET technology

Applications

Absolute Maximum Ratings ($T_A=25$



YJU3724A

NMOS Electrical Characteristics (T_J=25 unless otherwise noted)

Parameter	Symbol	Conditions	Min	Typ	Max	Units
Static Parameter						
Drain-Source Breakdown Voltage	BV _{DSS}	V _{GS} = 0V, I _D =250	30	-	-	V
Zero Gate Voltage Drain Current	I _{DSS}	V _{DS} =30V, V _{GS} =0V	-	-	1	
		V _{DS} =30V, V _{GS} =0V, T _J =150	-	-	100	
Gate-Body Leakage Current	I _{GSS}	V _{GS} = ± 20V, V _{DS} =0V	-	-	± 100	nA
Gate Threshold Voltage	V _{GS(th)}	V _{DS} = V _{GS} , I _D =250	1	1.5	2.5	V
Static Drain-Source On-Resistance	R _{DS(on)}	V _{GS} =10V, I _D =4A	-	26	35	m
		V _{GS} =4.5V, I _D =3A	-	41	55	
Diode Forward Voltage	V _{SD}	I _S =4A, V _{GS} =0V	-	-	1.2	V
Gate resistance	R _G	f=1MHz	-	2.5	-	
Maximum Body-Diode Continuous Current	I _S		-	-	4	A
Dynamic Parameters						
Input Capacitance	C _{iss}	V _{DS} =15V, V _{GS} =0V, f=1MHz	-	230	-	pF
Output Capacitance	C _{oss}		-	45	-	
Reverse Transfer Capacitance	C _{rss}		-	35	-	
Switching Parameters						
Total Gate Charge	Q _g	V _{GS} =10V, V _{DS} =15V, I _D =4A	-	6	-	nC
Gate-Source Charge	Q _{gs}		-	1.4	-	
Gate-Drain Charge	Q _{gd}		-	1.2	-	
Reverse Recovery Charge	Q _{rr}	I _F =4A, di/dt=100A/us	-	1.0	-	nC
Reverse Recovery Time	t _{rr}		-	5.5	-	ns
Turn-on Delay Time	t _{D(on)}	V _{GS} =10V, V _{DD} =15V, I _D =4A R _{GEN} =3	-	5	-	ns
Turn-on Rise Time	t _r		-	30	-	
Turn-off Delay Time	t _{D(off)}		-	8	-	
Turn-off fall Time	t _f		-	24	-	

PMOS Electrical Characteristics (T_J=25 unless otherwise noted)

Parameter	Symbol	Conditions	Min	Typ	Max	Units
Static Parameter						
Drain-Source Breakdown Voltage	BV _{DSS}	V _{GS} = 0V, I _D =-250	-30	-	-	V
Zero Gate Voltage Drain Current	I _{DSS}	V _{DS} =-30V, V _{GS} =0V	-	-	-1	
		V _{DS} =-30V, V _{GS} =0V, T _J =150	-	-	-100	
Gate-Body Leakage Current	I _{GSS}	V _{GS} = ± 20V, V _{DS} =0V	-	-	± 100	nA



YJU3724A

Gate Threshold Voltage	$V_{GS(th)}$	$V_{DS} = V_{GS}, I_D = -250$	-1	-1.5	-2.5	V
Static Drain-Source On-Resistance	$R_{DS(on)}$	$V_{GS} = -10V, I_D = -3A$	-	58	75	m
		$V_{GS} = -4.5V, I_D = -3A$	-	85	110	
Diode Forward Voltage	V					



NMOS Typical Electrical and Thermal Characteristics Diagrams

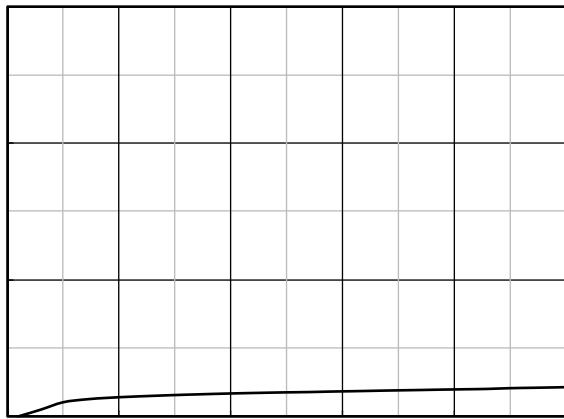

Figure 1. Output Characteristics

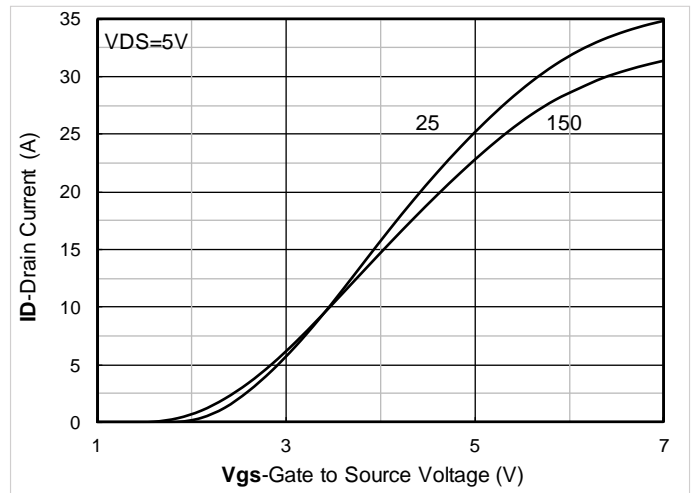

Figure 2. Transfer Characteristics

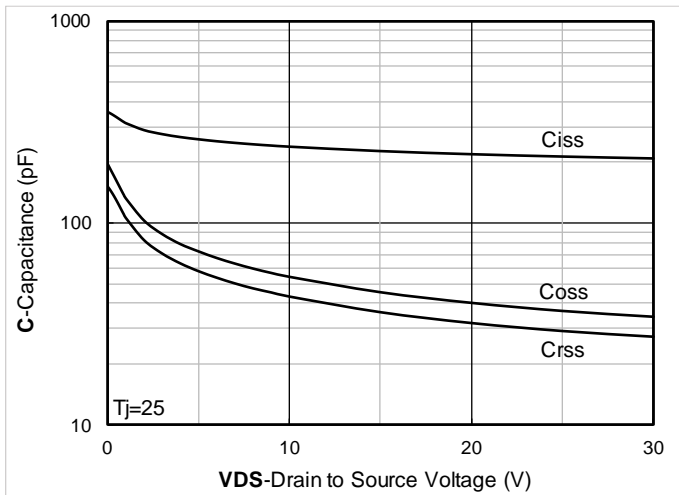

Figure 3. Capacitance Characteristics

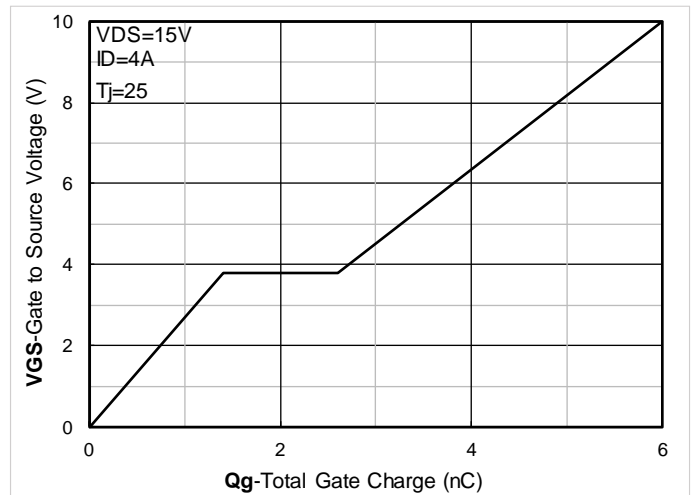

Figure 4. Gate Charge

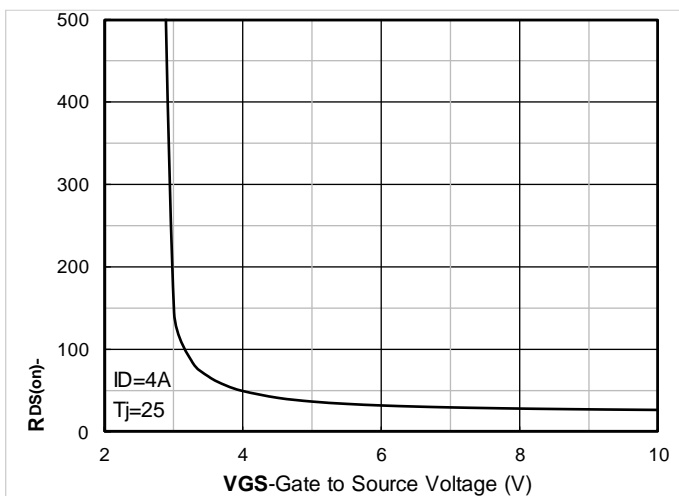

Figure 5. On-Resistance vs Gate to Source Voltage

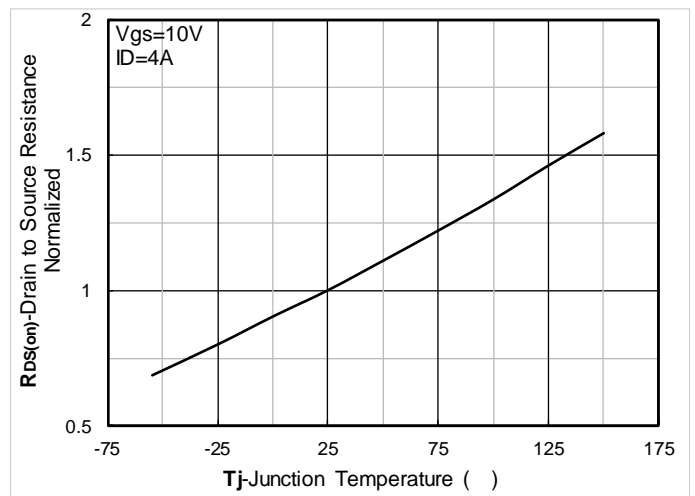

Figure 6. Normalized On-Resistance

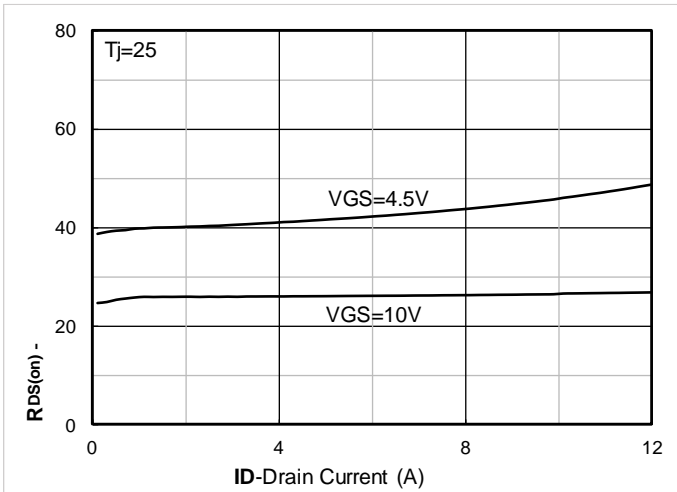

Figure 7. RDS(on) VS Drain Current

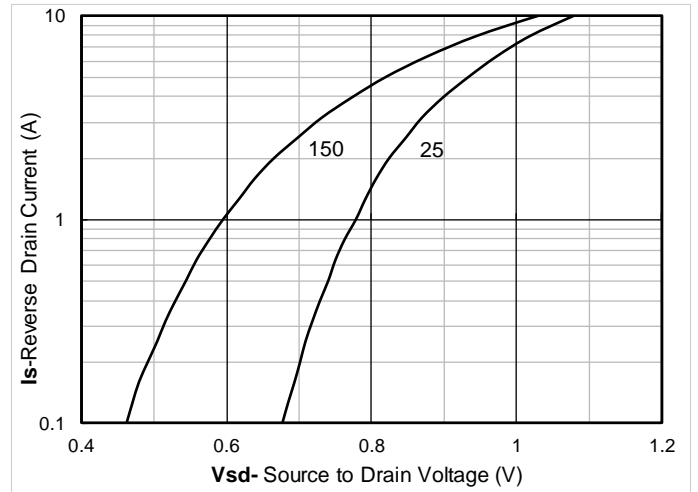

Figure 8. Forward characteristics of reverse diode

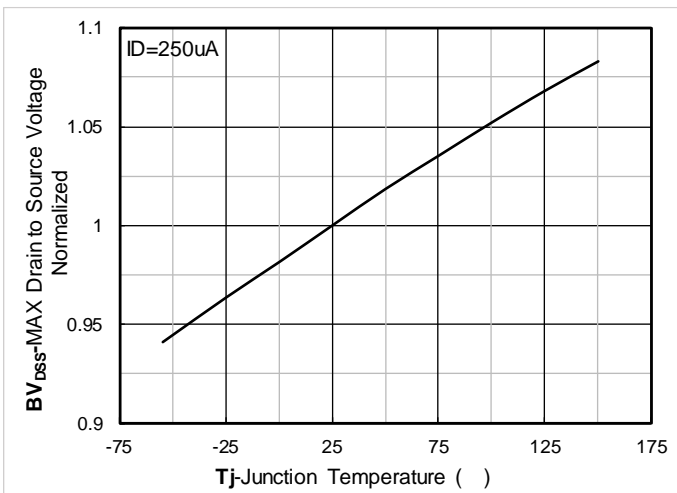

Figure 9. Normalized breakdown voltage

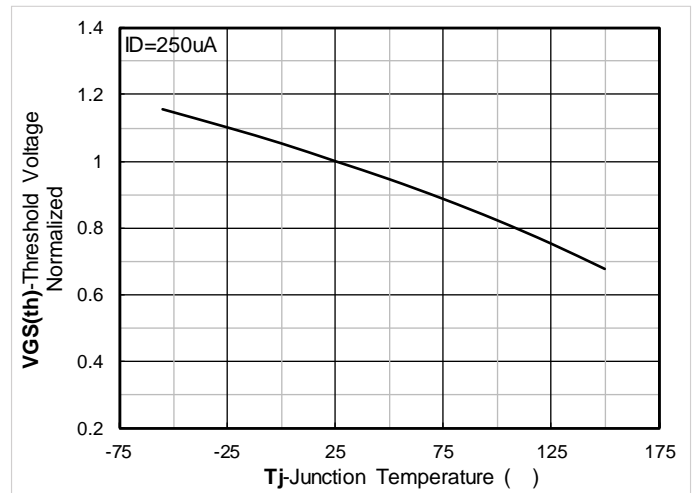

Figure 10. Normalized Threshold voltage

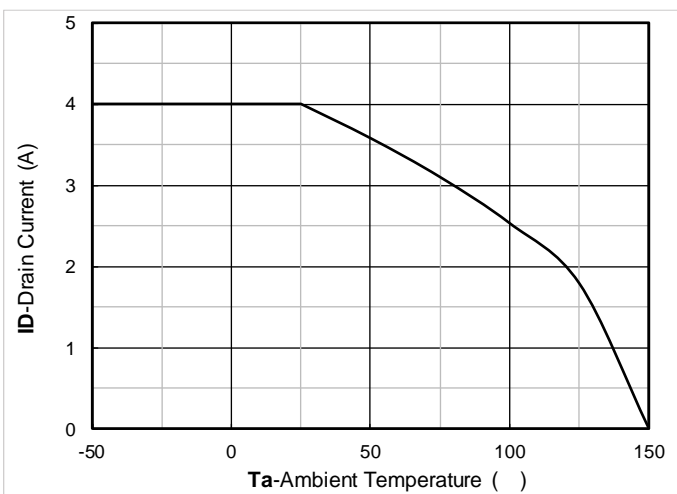

Figure 11. Current dissipation

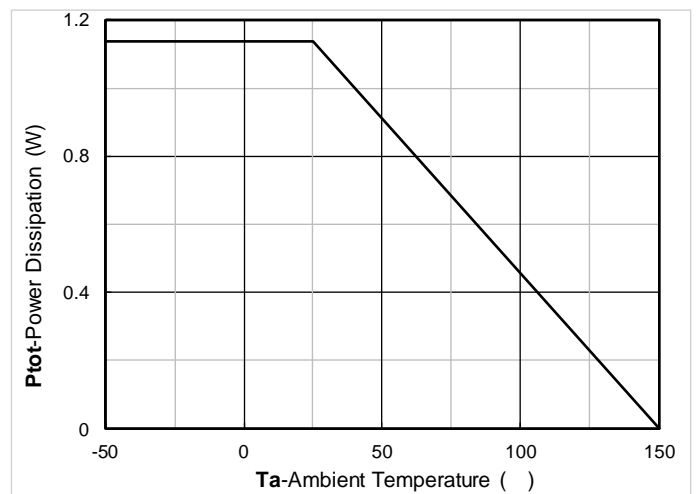

Figure 12. Power dissipation

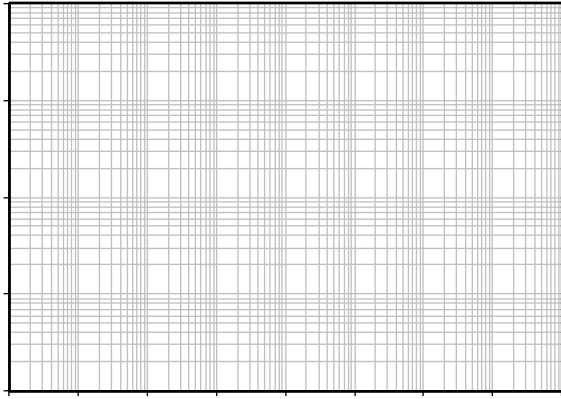

Figure 13. Maximum Transient Thermal Impedance

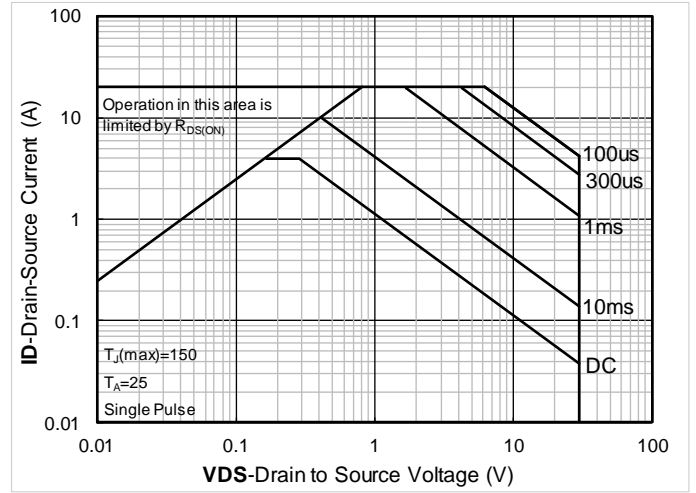

Figure 14. Safe Operation Area

PMOS Typical Electrical and Thermal Characteristics Diagrams

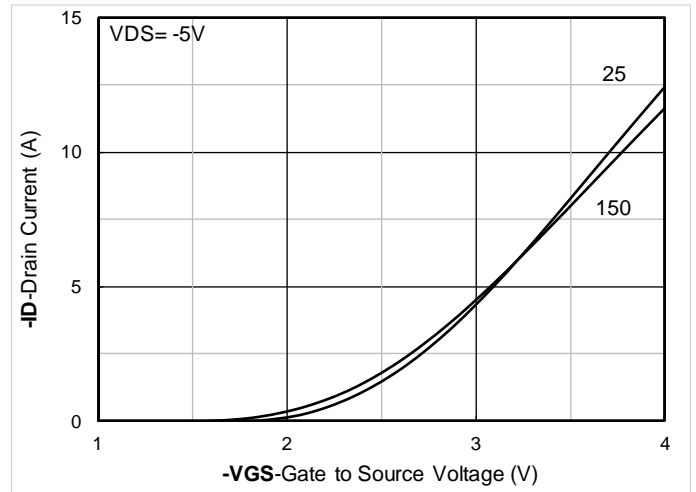

Figure 2. Transfer Characteristics

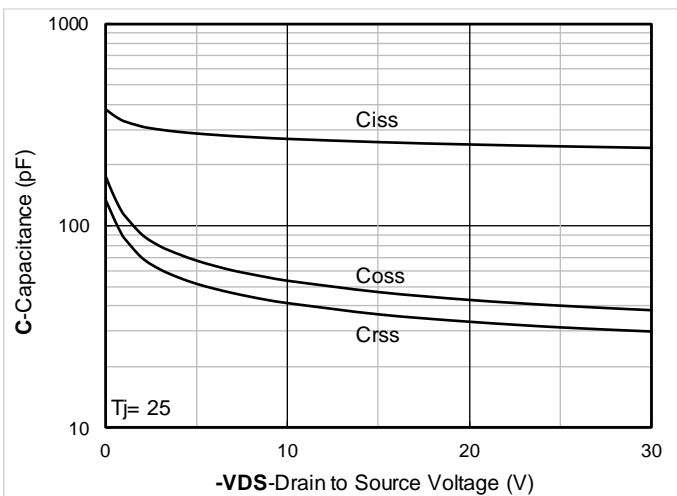

Figure 3. Capacitance Characteristics

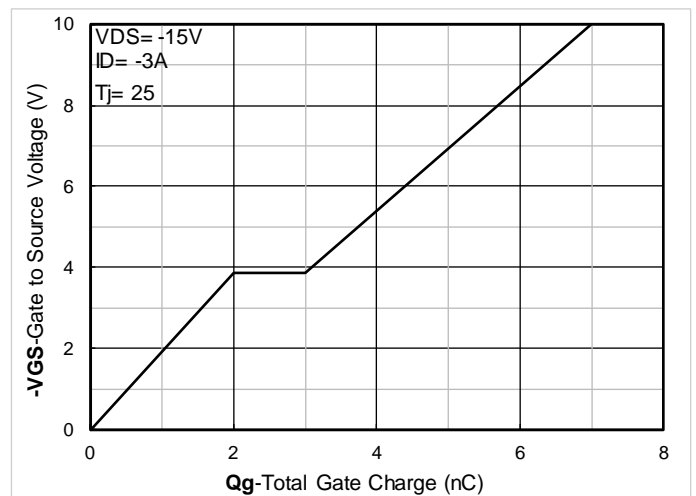

Figure 4. Gate Charge

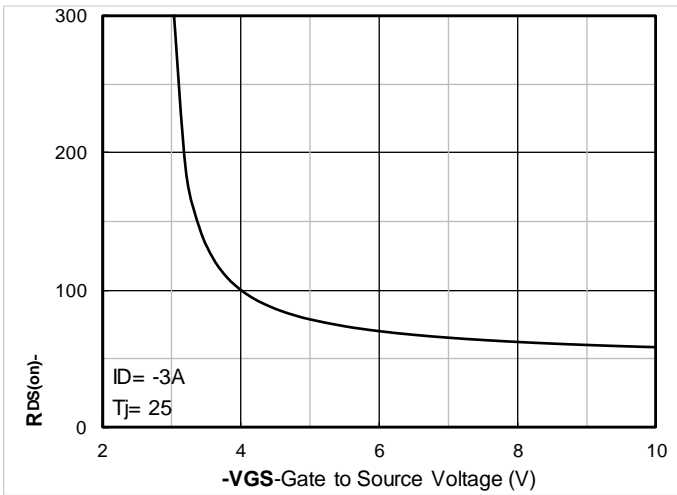

Figure 5. On-Resistance vs Gate to Source Voltage

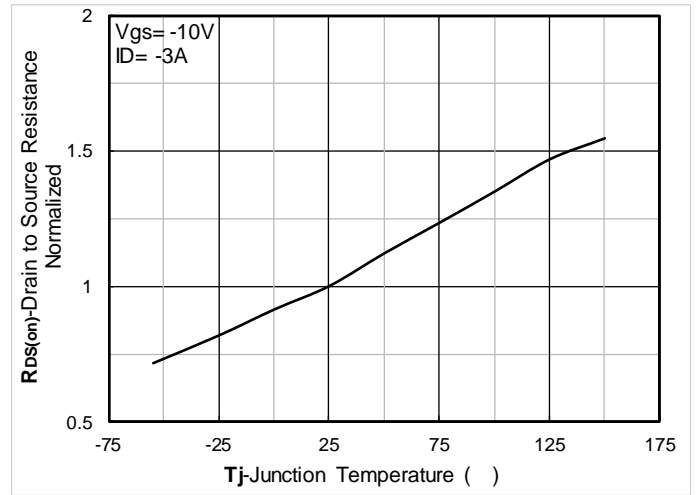

Figure 6. Normalized On-Resistance

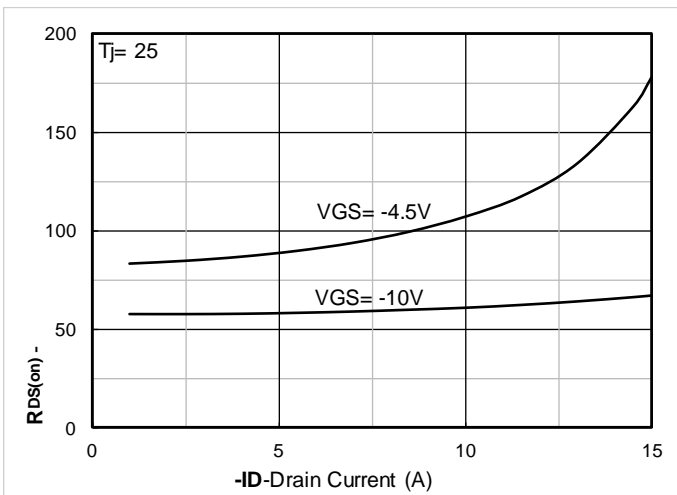

Figure 7. RDS(on) VS Drain Current

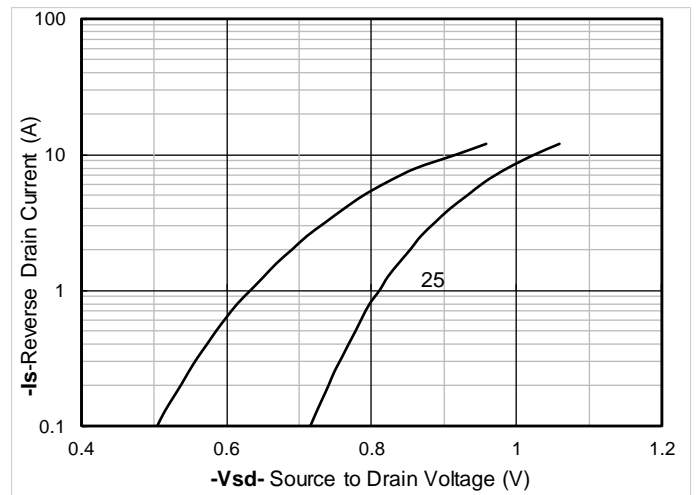

Figure 8. Forward characteristics of reverse diode

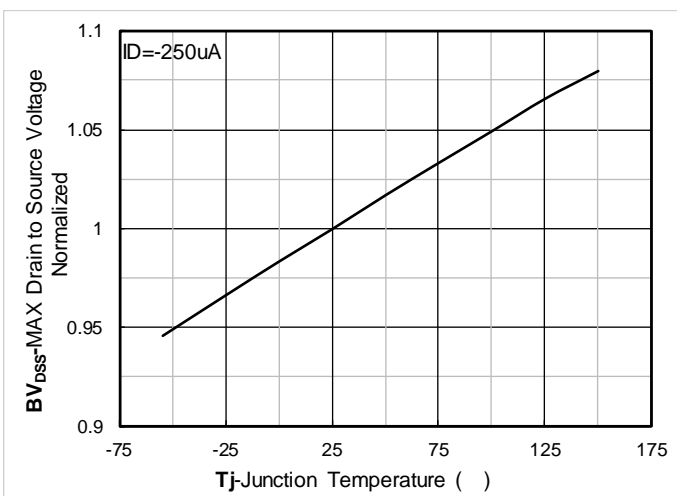

Figure 9. Normalized breakdown voltage

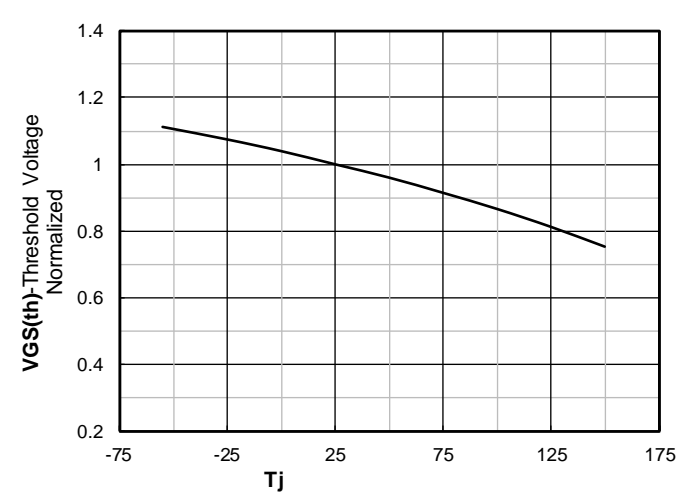

Figure 10. Normalized Threshold voltage

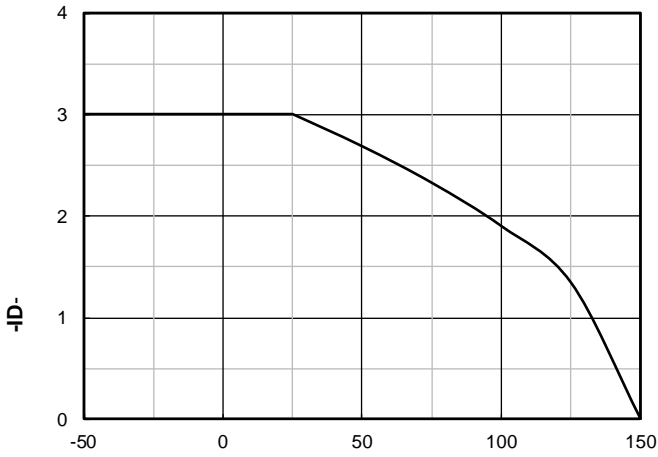

Figure 11. Current dissipation

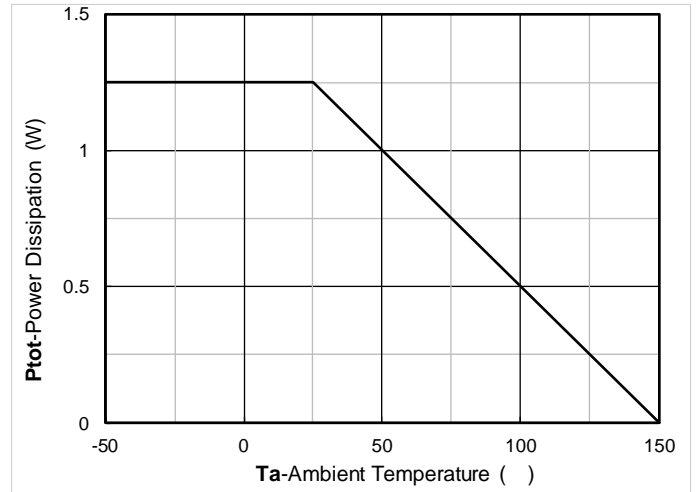

Figure 12. Power dissipation

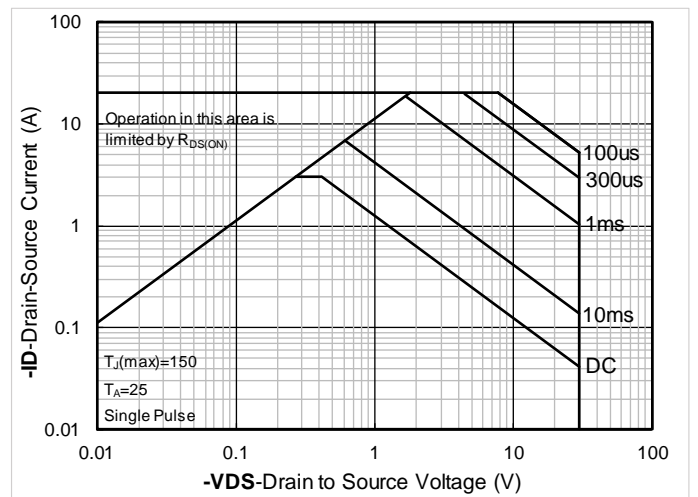

Figure 14. Safe Operation Area

Figure 13. Maximum Transient Thermal Impedance



PDFN3030-8L Package information

TOP VIEW

SIDE VIEW

BOTTOM VIEW



Disclaimer

The information presented in this document is for reference only. Yangzhou Yangjie Electronic Technology Co., Ltd. reserves the